

**Smart Operation Panel Type M3  
Machine Code: D148  
Field Service Manual**

July, 2014  
Subject to change



# Revision Lists

Version	Section	Details
1.00	-	Initial release of this document. Created this manual for D176/D177 series.
1.10	All	Revised all sections according to the release of D197 series
		Modified some parts name.
	Read This First > Safety and Symbols	Added this section.
	Installation > Installation Procedure	Deleted this section..
	Replacement and Adjustment > Operation Panel Unit > Microcomputer Board	Modified the procedure.
	Replacement and Adjustment > Operation Panel Unit > CPU Board	Modified Step 6.
	Replacement and Adjustment > Operation Panel Unit > I/O Board	Modified Step 5.
	Replacement and Adjustment > Operation Panel Unit > Microphone	Modified Step 3.
	Mechanism > Overview > Available languages	Modified some typos.
	Mechanism > Overview > 1. Key specification	Modified some keys name.
	Mechanism > Overview > Electrical Components	Modified some description.
	Mechanism > Power Supply Control > Energy-Save Recovery Operation	Modified some keys name. Deleted duplicated description.
	Mechanism > Power Supply Control > Screen Startup Mode	Added a Note. Modified some typos.





---

Version	Section	Details
	Mechanism > Power Supply Control > Special Shutdown	Added this procedure.
	System Maintenance > Version Update > Preparing Version Update SD card	Added this item.
	System Maintenance > Version Update > Version Update Procedure	Modified the description. Modified some keys name.
	System Maintenance > Application Installation/Version Update > Version update via SD card	Added this item.
	System Maintenance > Self-Diagnosis	Modified some keys name.

---

# Safety and Symbols

This manual uses several symbols and abbreviations. The meaning of those symbols and abbreviations are as follows:

	Clip ring
	Screw
	Connector
	Clamp
SEF	Short Edge Feed
LEF	Long Edge Feed

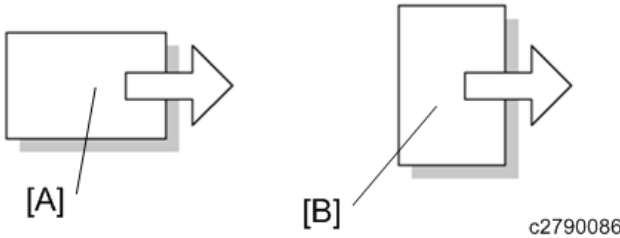

[A] Short Edge Feed (SEF)

[B] Long Edge Feed (LEF)

---

## Trademarks

---

Microsoft®, Windows®, and MS-DOS® are registered trademarks of Microsoft Corporation in the United States and /or other countries.

PostScript® is a registered trademark of Adobe Systems, Incorporated.

PCL® is a registered trademark of Hewlett-Packard Company.

Ethernet® is a registered trademark of Xerox Corporation.

PowerPC® is a registered trademark of International Business Machines Corporation.

Android is a trademark of Google Inc.

Other product names used herein are for identification purposes only and may be trademarks of their respective companies. We disclaim any and all rights involved with those marks.

# TABLE OF CONTENTS

---

Revision Lists.....	1
Safety and Symbols.....	3
Trademarks.....	3

## 1. Replacement and Adjustment

---

Operation Panel Unit.....	7
Operation Panel.....	7
Microcomputer Board.....	8
CPU Board.....	11
I/O Board.....	12
Speaker.....	13
LCD.....	13
Microphone.....	15

## 2. Mechanism

---

Overview.....	17
System Components.....	17
Specification.....	18
Available languages.....	19
Appearance/Screen Layout.....	19
1. Key specification.....	19
2. LED specification.....	20
3. External I/F specification.....	21
4. Screen layout.....	21
Electrical Components.....	22
Power Supply Control.....	23
Energy-Save Recovery Operation.....	23
Screen Startup Mode.....	24
Special Shutdown.....	25

## 3. System Maintenance

---

System Maintenance.....	27
Basic Operation.....	27
Switching the Power OFF before Performing Maintenance (before Disconnecting the Power Supply Plug).....	27
Switching the Power OFF before Upgrading the MFP (Controller/Engine) Version.....	27

---

Reset Procedure If the Android Screen Freezes.....	27
Maintenance Modes.....	27
Version Update.....	28
Preparing Version Update SD card.....	28
Version Update Procedure.....	28
Application Installation/Version Update.....	31
Version update via SD card.....	31
Self-Diagnosis.....	31
SP Mode List.....	36
Settings Menu List.....	36
Recovery Menu.....	39





# 1. Replacement and Adjustment

## Operation Panel Unit

1

### Operation Panel

1. Scanner front cover (Scanner front cover)
2. Operation panel upper cover [A] (hook×2)

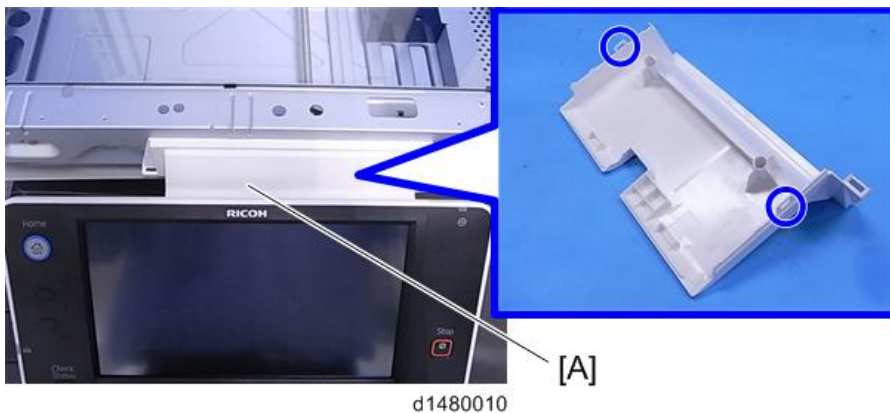

3. Operation panel [A] (  x5,  x3,  x2)

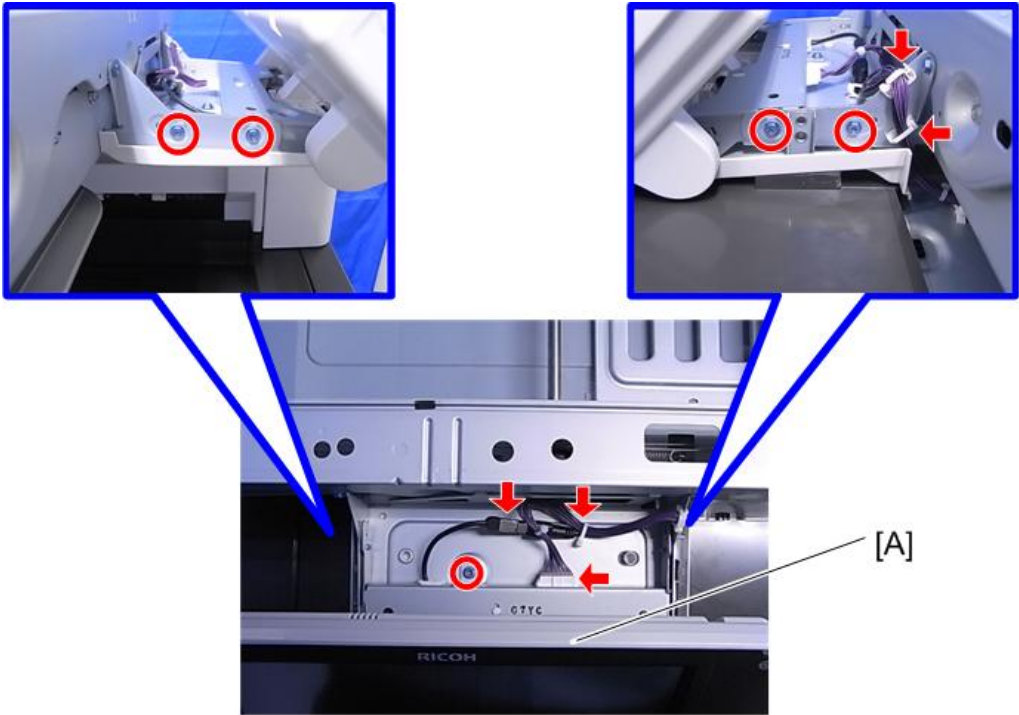

d1480011

---

## Microcomputer Board

---

1. Operation panel (page 7)

2. Remove four screw covers.

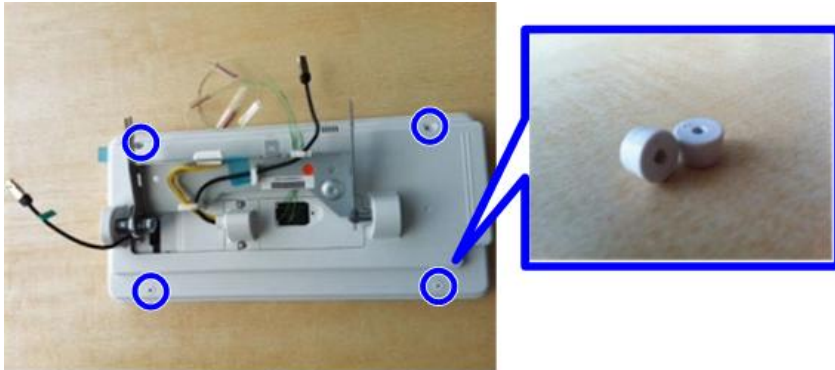

d1464004

3. Operation panel rear cover [A] (⚙️×4, hook×4)

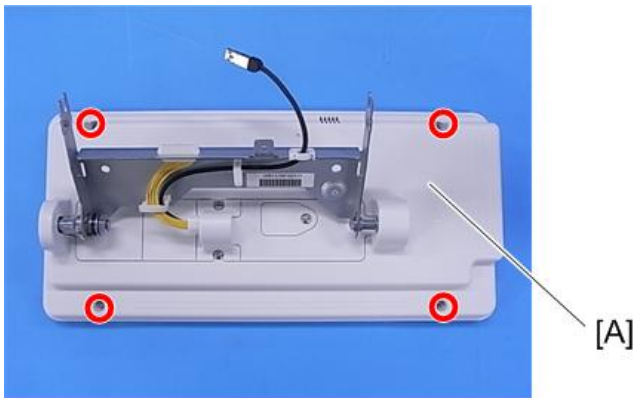

d1480012

↓ Note

- There are 4 hooks inside the operation panel. Before removing the operation panel rear cover, see the photos below.



d1480013

4. Operation panel arm bracket [A] (  x7,  x3,  x1)

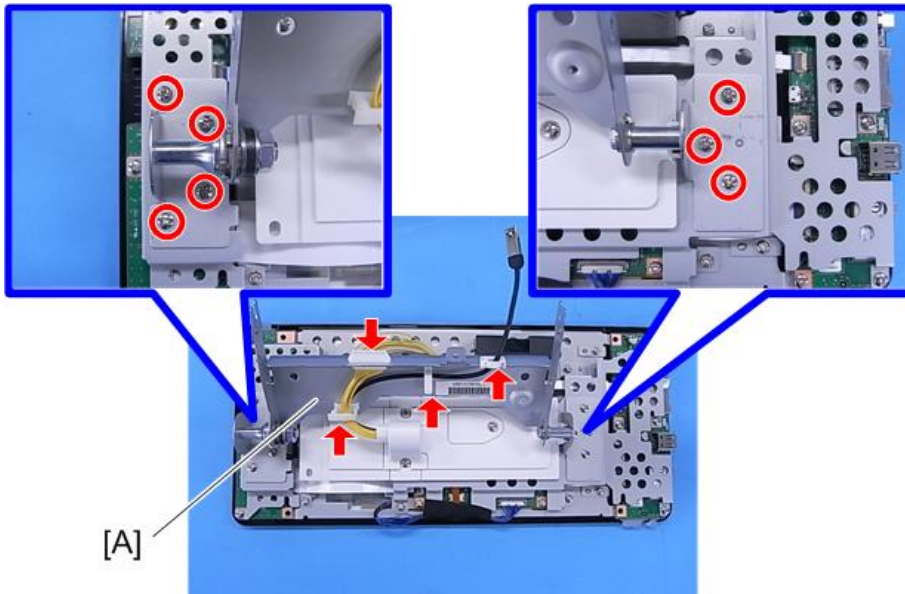

d1480014

5. Bracket [A] (  x6)

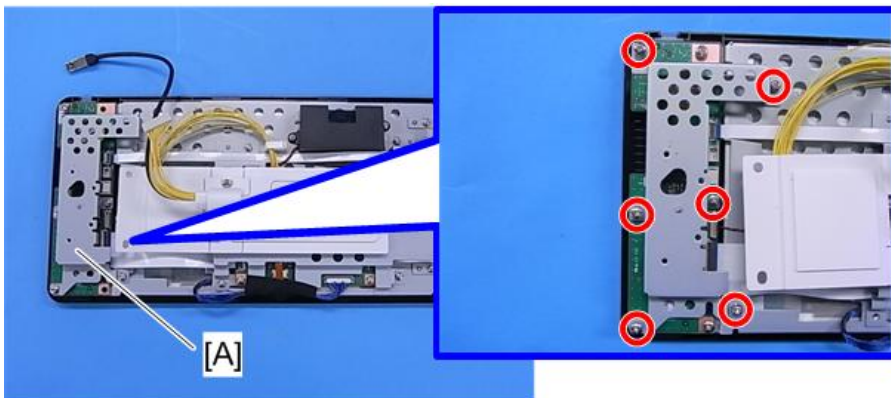

d1480015

## 6. Microcomputer Board [A] (FFC×2)

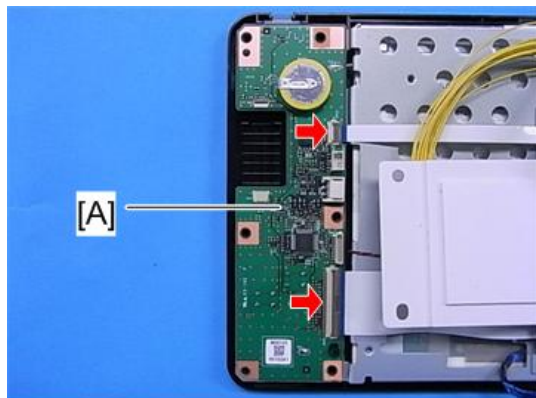

d1480016

## CPU Board

1. Operation panel (page 7)
2. Operation panel rear cover (page 8)
3. Operation panel arm bracket (page 8)
4. Harness guide [A] and bracket cover [B] (⌀×2).

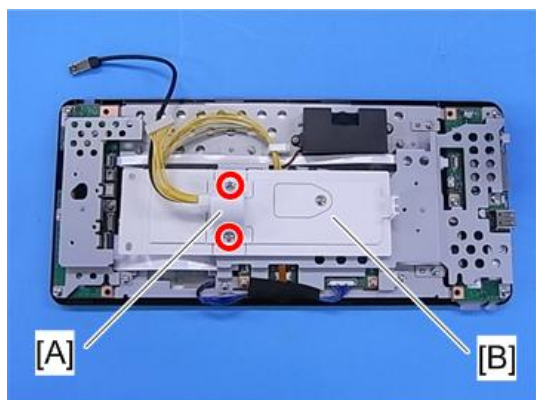

d1480017

5. Bracket [A] (  ×6,  ×1, tape ×1 )

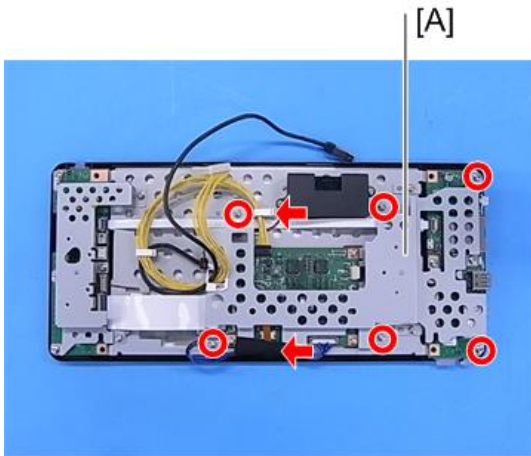

d1480018

6. CPU Board [A] (  ×4,  ×6, FFC ×3 )

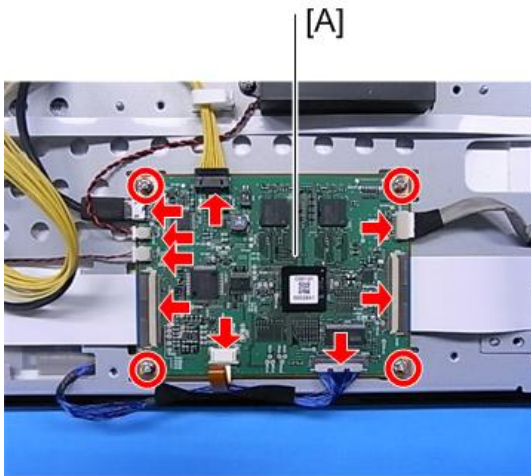

d197z0196

---

## I/O Board

---

1. Operation panel (page 7)
2. Operation panel arm bracket (page 8)
3. Harness guide and bracket cover (page 11)
4. Bracket (page 11)





### 5. I/O Board [A] ( x1, FFCx2)



d1480020

## Speaker

1. Operation panel (page 7)
2. Operation panel rear cover (page 8)
3. Operation panel arm bracket (page 8)
4. Harness guide and bracket cover (page 11)
5. Bracket (page 11)
6. Speaker [A] (  x2,  x1)

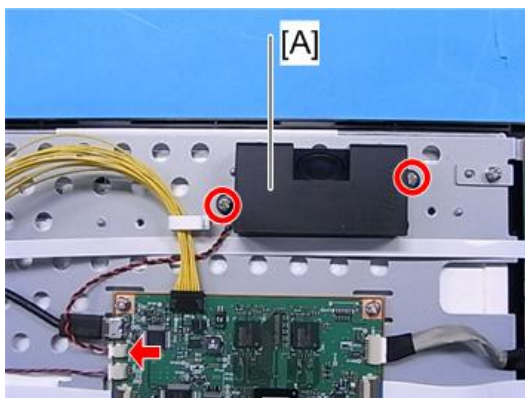

d1480021

## LCD

1. Microcomputer Board (page 8)
2. CPU Board (page 11)

3. I/O Board (page 12)

4. Speaker (page 13)

5. Remove the LCD with the bracket [A] (🔩×2).

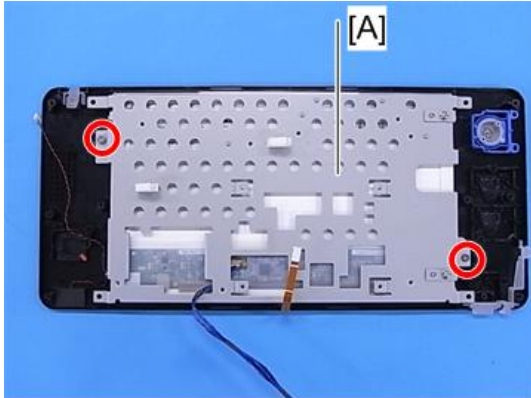

d1480022

6. Remove the bracket [A] from the LCD (🔩×4).

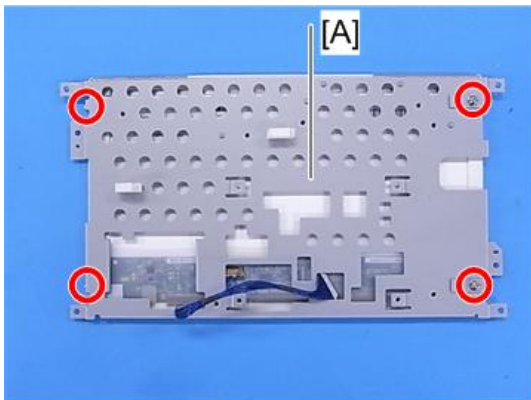

d1480023



7. LCD [A] (  x1)



d1480024

---

## Microphone

---

1. Microcomputer Board (page 8)
2. CPU bracket (page 11)
3. Disconnect a connector. (  x1)



d1480025

4. Microphone [A] (cushioning×1)

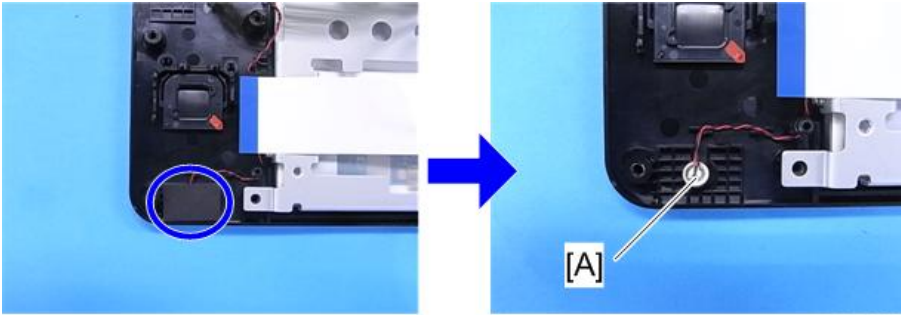

d1480026

# 2. Mechanism

## Overview

### System Components

The Android control unit is a control unit in which the Android OS connected with the MFP by USB, is installed.

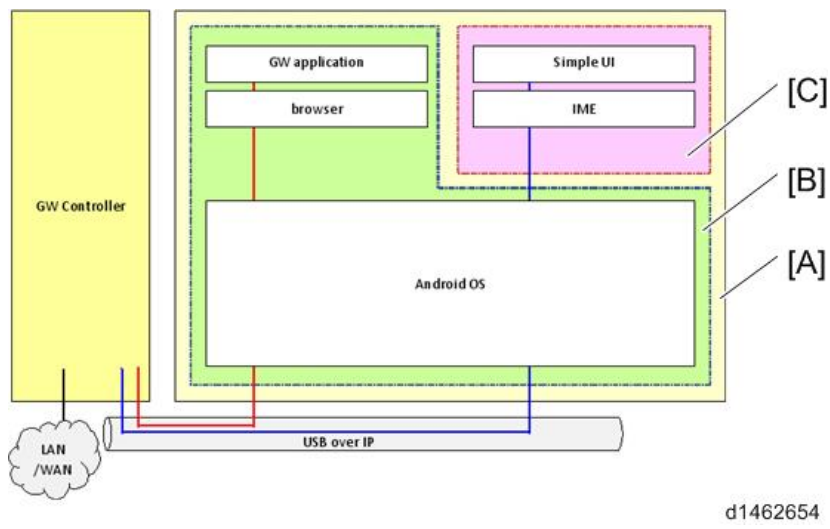

[A]: Android screen

[B]: Android firmware (update from recovery mode)

[C]: Android application (perform installation version update from screen SP mode)

## Specification

Category	Item	Contents	Remarks
LCD	Size	10.1 inch panel	
	No. of pixels	WSVGA (1024×600)	
	Bit width	RGB666	18-bit color
	Brightness	200cd/m <sup>2</sup> (typ.)	
	Back light	LED rear light (lifetime 15000h)	
Touch panel		Light load touch panel, 2 -point touch detection	
Memory	Volatile memory	RAM: 1GB	
	Non-volatile memory	NAND: 2GB	Program area and data area for the OS and applications
External I/F	USB memory	USB2.0 Host Type-A	
	SD card	SD card slot 1ch (SD/SDHC)	
	USB	USB2.0 Host Type-mini AB	Not available
Network	Wireless LAN	802.11b/g/n	
Audio input/output	Speaker/ microphone	Monophonic speaker 1ch (power 1-2W) Microphone	
Power consumption	When active	During regular time: Less than 4W During wireless-LAN high-load operation: Less than 4.6W	Excluding external I/F and internal function expansion.
	During sleep	Less than 350 mW	In sleep mode or while the power is off, do not supply power to an extension USB device connected to an external USB port.

## Available languages

Japanese, American English, German, French, Italian, Spanish, Dutch, Russian, Chinese (simplified Chinese characters) and Chinese (traditional Chinese characters)

## Appearance/Screen Layout

The Android control unit is a control unit in which the Android OS connected with the MFP by USB, is installed.



No.	Description	No.	Description
1	USB slot	9	"Data In" LED
2	USB LED	10	FAX LED
3	SD slot	11	Menu key (Only used for Android Apps)
4	SD LED	12	Back key (Only used for Android Apps)
5	mini USB slot	13	Home key
6	reset key	14	Main power / Energy save LED
7	Check status key	15	Stop key
8	Status LED		

### 1. Key specification

Key	Description
Home	Change to home screen.

Key	Description
Status check	Change to status display screen.
Stop	Change to stop screen.
Back	Return to previous screen. (The return destination may be the home screen).
Menu	Change to the menu screen of a displayed application. In case of an application without a menu screen, it does not operate.
Reset button	Reboot the control unit.

\* The Back and Menu keys are used for operation of Android applications (browser, gallery, etc.).

## 2. LED specification

LED	Description
Power supply	Shows the OFF/ON status of the power supply.
Home	Shows the HOME screen.
FAX	Displays the fax status. <ul style="list-style-type: none"> <li>• During communication: Blinks</li> <li>• Proxy receive (FAX): Lights</li> <li>• Confidential receipt (FAX): Lights</li> </ul>
Data-in	Displays the printer data status.
Status check	Displays the device status.
Main power supply	Shows energy-save and power supply status.
SD access	Shows SD access status.
USB access	Shows USB access status.

### 3. External I/F specification

External I/F	Description
SD card slot	Available from both GW application/Android application. (to use, change over).
USB slot	Available only from GW application
mini USB slot	Not available

2

### 4. Screen layout

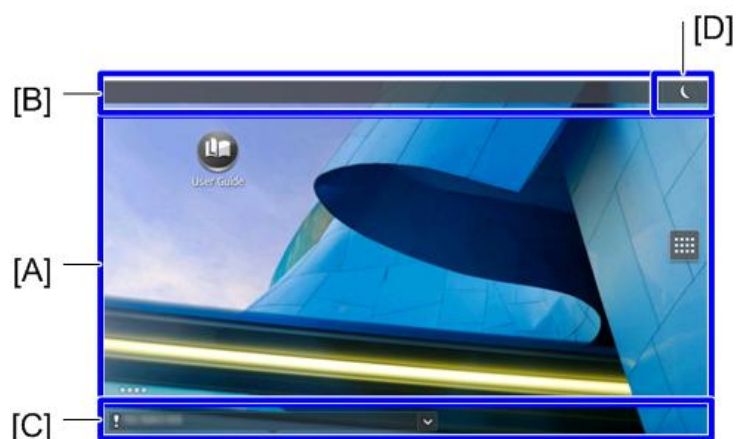

d1462657

No.	Part name	Description
[A]	Application screen area	This is the application display area.
[B]	Login banner	Display login information.
[C]	System banner	Perform banner display.
[D]	Energy-save button	Perform energy-save shift and recovery.

**Electrical Components**

2

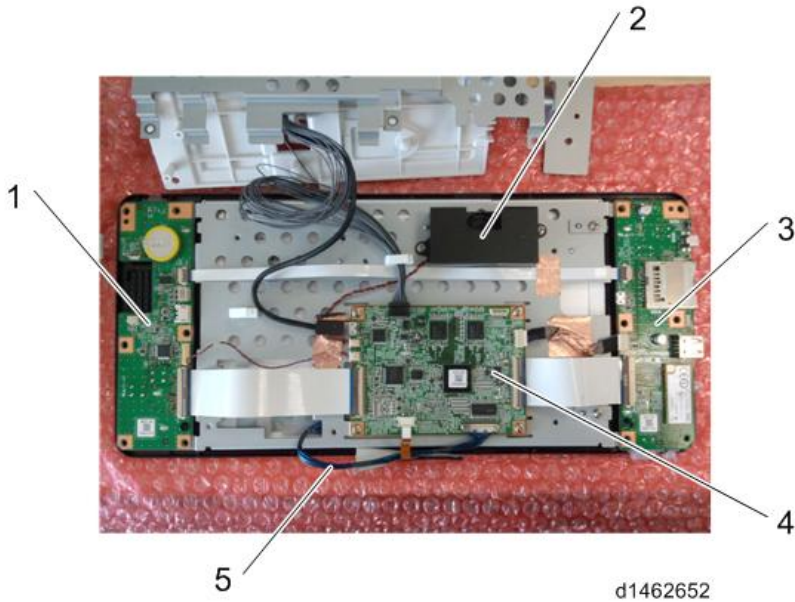

d1462652

No.	Item	Description
1	Microcomputer board	Board with microcomputer which performs (energy-save) power supply control of the control unit
2	Speaker	-
3	I/O board	Board with external IF connector (also, a WLAN module)
4	CPU board	Main board with main control CPU
5	LCD (liquid crystal) I/F cable	Small gauge coaxial



# Power Supply Control

## Energy-Save Recovery Operation

An Android screen is different from a conventional screen (standard screen) in the method of recovery from energy-saving mode.

2

Key	Android control unit	Standard control unit
HOME	Perform energy-save recovery, and display home screen. (Equivalent to standard control unit [Energy-save] key)	Does not recover.
Status check	Perform energy-save recovery, and display status confirmation screen.	Same left
Energy-save	No key	Perform energy-save recovery, and display priority application screen. * During recovery from low power mode, display application screen before shift.
LCD touch	Perform energy-save recovery, and display status confirmation screen. (Equivalent to standard control unit [Energy-save] key)	Does not recover.
Back	Perform energy-save recovery, and display status confirmation screen. (Equivalent to standard control unit [Energy-save] key)	No corresponding key
MENU	Perform energy-save recovery, and display status confirmation screen. (Equivalent to standard control unit [Energy-save] key)	No corresponding key
STOP	Perform energy-save recovery, and display status confirmation screen. (Equivalent to standard control unit [Energy-save] key).	Does not recover.

Key	Android control unit	Standard control unit
Login/logout	No key	Does not recover.

## Screen Startup Mode

2

As control unit start-up modes, a Normal Startup Mode (power-saving mode) and Quick Startup Mode are provided. Each mode can be changed over from Screen Features → Screen Device Settings → Screen Startup Mode.

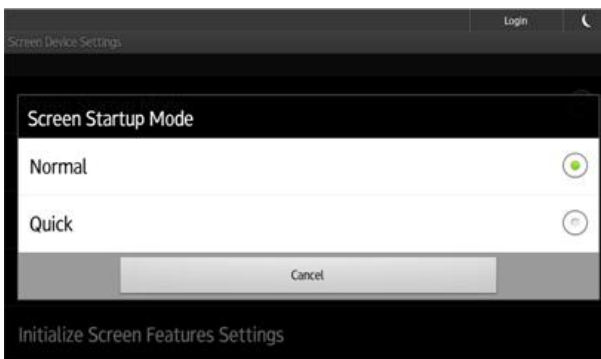

d1462656

### 1. Normal Startup Mode (power-saving mode): Default

This is a mode with minimum power. Since the power is reduced to the minimum, normal startup will take time (start-up time guide: 68 seconds).

### 2. Quick Startup Mode

In this mode, a minute amount of power is supplied to the screen even when the power is OFF, and the home screen is displayed immediately when the power is switched ON. (start-up time guideline: 17 seconds)

In Quick Startup Mode, preparations for the next startup are performed even during shutdown. Therefore, shutdown takes longer than in Normal Startup Mode.

#### ↓ Note

- To avoid preparations for the next startup, press the power button while holding the "Stop" key until the shutting down message shows up. This may help you shut down smoothly when you are maintaining the machine.

#### ↓ Note

- When shutdown is performed in Quick Startup Mode, the screen changes in the following order:
  1. Displays the shutting down message on the screen.
  2. The screen turns off.

3. The power LED blinks.
4. The power LED turns off.

---

## Special Shutdown

---

To facilitate maintenance, the following two shutdown procedures are provided:

1. Maintenance shutdown (shortens shutdown time)

When the Quick Startup Mode is set, preparations for the next start-up are performed during shutdown, so shutdown takes more time than in normal start-up mode. If the power is switched OFF by the following steps, even if the Quick Startup Mode is set, the same shutdown is performed as in normal mode (shutdown time is shortened).

**Procedure:** Press the power button while holding the “Stop” key until the shutting down message shows up.

2. MFP version update shutdown (screen remains energized)

When the MFP controller or engine firmware version is updated, if shutdown and start-up of the Android screen take time, working efficiency decreases. Therefore, by performing the following procedure, the MFP controller/engine can be powered off alone without completely shutting down the Android screen.

**Procedure:** Press the power button while holding the “Back” key until the shutting down message shows up.

 **Note**

- After shutdown is completed by this procedure, when the MFP is left for 5 minutes or longer, it starts up in normal startup mode the next time that the power is switched ON.



# 3. System Maintenance

## System Maintenance

### Basic Operation

#### Switching the Power OFF before Performing Maintenance (before Disconnecting the Power Supply Plug)

3

1. Press the power switch while pressing the [STOP] key.  
Continue pressing the [STOP] key until "Shutting Down" is displayed.

#### ↓ Note

- Shutdown can be performed in a short time even when the Quick Startup Mode is set.

#### Switching the Power OFF before Upgrading the MFP (Controller/Engine) Version

1. Press the power switch while pressing the [STOP] key.  
Continue pressing the [STOP] key until "Shutting Down" is displayed.

#### ↓ Note

- When upgrading the Android screen firmware version, switch the power OFF by the normal procedure.

#### Reset Procedure If the Android Screen Freezes

#### ↓ Note

- If reset is performed when the Android screen is in operation, data stored in the Android screen may be corrupted.
1. Press the reset button on the left side of the control unit in order to reboot the control unit.

### Maintenance Modes

The different service modes and their roles are as follows.

\* For security reasons, the specific methods for switching between service modes are not given here. Please check according to the usual procedure.

Mode	Application	Remarks
MFP SP mode	MFP (engine) <ul style="list-style-type: none"> <li>Conventional SP mode</li> </ul>	Since a 10-keypad is used for mode shift, mode shift must be performed from a GW application.
Screen service mode	Android-specific screen service mode <ul style="list-style-type: none"> <li>Android application installation and version update</li> <li>Screen self-diagnosis check</li> </ul>	Idem
Recovery mode	Android OS maintenance <ul style="list-style-type: none"> <li>OS update</li> <li>Full data format</li> </ul>	-

## Version Update

### Preparing Version Update SD card

1. Download the update module "update\_sig.zip".
2. Move the downloaded file to the root directly of the SD card.

#### ↓ Note

- Do not unzip the downloaded file.

### Version Update Procedure

Android firmware (OS) version update is performed from recovery mode.

#### ↓ Note

- If Quick Startup is set, it is not possible to shift to recovery mode. It is necessary to perform either shutdown from Normal Startup Mode, or shutdown by the power OFF procedure prior to maintenance (before disconnecting the power supply plug).

#### ↓ Note

- If extended security for firmware update is set to "prohibit", it is not possible to shift to recovery mode. (System Settings>Administrator Tools>Extended Security is displayed in log-on screen for machine administrator)

- If firmware update is required with the above settings, ask customer (machine administrator) to request a change of the setting.

1. Turn off the main power.
2. Insert the SD card in the control unit SD slot, and start the recovery mode.
3. Select "apply update from sdcard.", and press [Home] key.

**Note**

- Screen operations are as follows.  
OK: [HOME] key.  
UP: [Back] key.  
DOWN: [Menu] key.

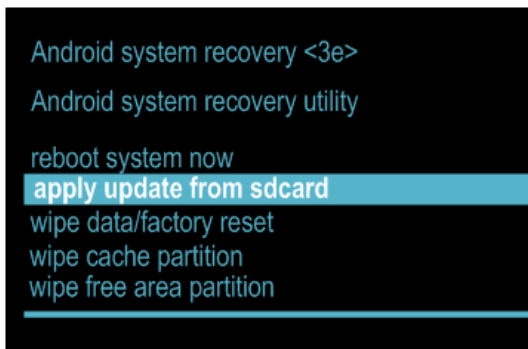

d148f0001

4. Select "update\_sig.zip", and press the [HOME] key.

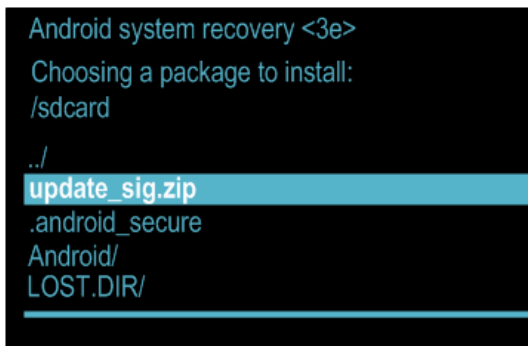

d148f0002

5. The installation screen is displayed.

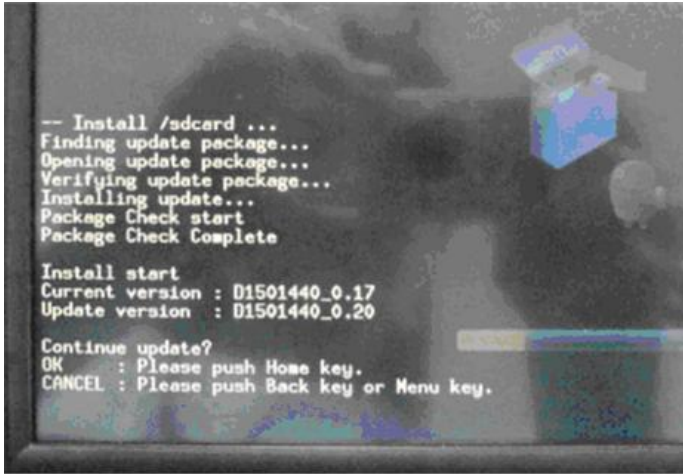

d1480003

6. The current version of the firmware, and the update version of the firmware in the SD card are displayed. Check that the version is correct.

7. When "Continue Update?" is displayed, press OK ([HOME] key).

8. Version Update is started.

9. When "Install from SD card complete." is displayed, select "reboot system now", press the [HOME] key, and perform a system reboot.



d1480004



## Application Installation/Version Update

### Version update via SD card

#### Preparing the version update SD card

1. Download the update file. (.zip)
2. Create the folder "app" on root directly.
3. Move the downloaded file to the app folder.

#### ↓ Note

- Do not unzip the downloaded file.

#### Version Update Procedure

1. Shift to screen service mode.
2. Set a version update SD card in the screen SD slot.
3. Select "Application" → "Install" → "Install from SD card", and start installation.
4. Select the application for which the version is to be updated, and press the "Install Button".
5. The version update result is displayed.
6. Check the version update result, and press down the "Panel reboot" button.

## Self-Diagnosis

The following menus can be performed as self-diagnosis functions of the control unit. Either Japanese or English can be displayed.

Self Check	
LED Check	Speaker Check
Key Check	Touch Panel Check
LCD Check	Wireless LAN Check
Touch Panel Calibration	

w\_d1462660

1. LED Check

The following control unit LED can be changed over between all on/all off.

- Data in
- USB access
- HOME
- Status check (When lit, R->G->B->R->G->B is repeated at 500 ms intervals)
- BACK/MENU
- FAX
- SD access

3

2. Key check

Check pressing hard keys other than the [HOME] key on the control unit. When a key is depressed, the corresponding key displayed on the control unit is shown highlighted.

If a foot switch is fitted, while the switch is depressed, the "FOOT SW" column is highlighted.

When the [End] key is depressed, the display returns to the self-diagnosis top screen (the Back key works as a key check, so it cannot be used as a key to return to the self-diagnosis top screen).

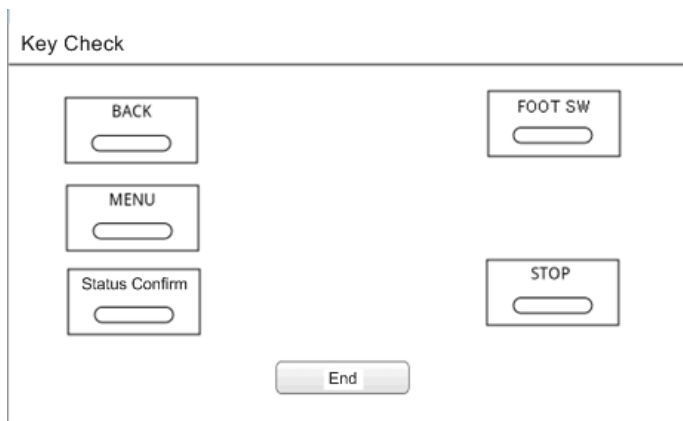

w\_d1462661

3. LCD Check

Whenever the screen is touched, the display cycles through All-white -> All-black -> All-green -> All-blue -> End in full screen view, and the display status of each color is visually verified.

By cycling through all the colors, the LCD check is completed, and the display returns to the self-diagnosis top screen.



d1462662

3

#### 4. Speaker check

The following standard sounds are generated according to the button instructions on the screen.

- Frequency: 220 Hz, 440 Hz, 880 Hz, 1760 Hz, 2000 Hz
- Sound volume: 16 levels from minimum to maximum
- Sounds standard sound by START/STOP toggle switch

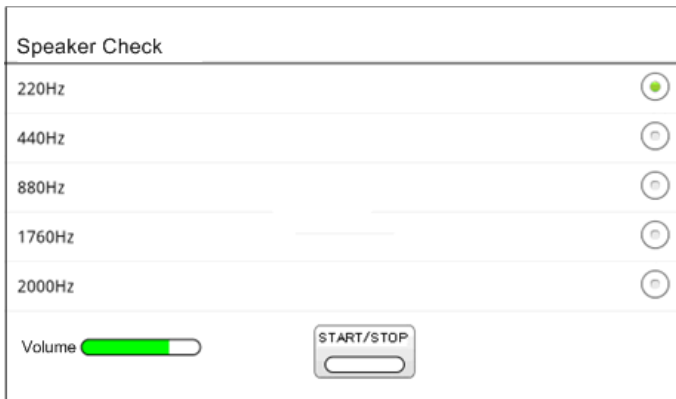

w\_d1462663

#### 5. Wireless LAN check

Changes to a screen for searching wireless LAN access points with Android as standard, and a communication status check is displayed.

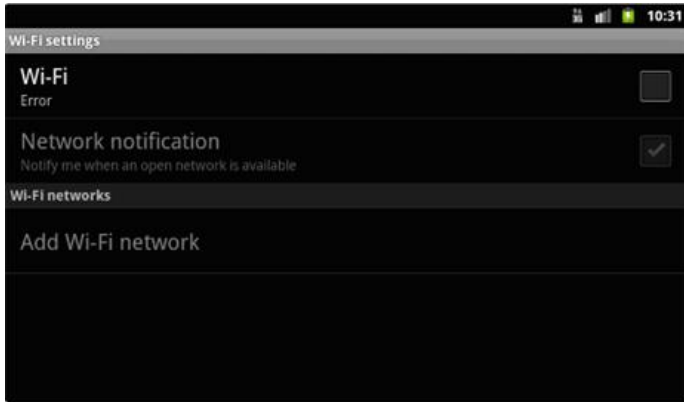

d1462664

6. Touch panel check

Displays the difference of a detection coordinate value from the nearest reference point relative to a standard 9 points on the screen.

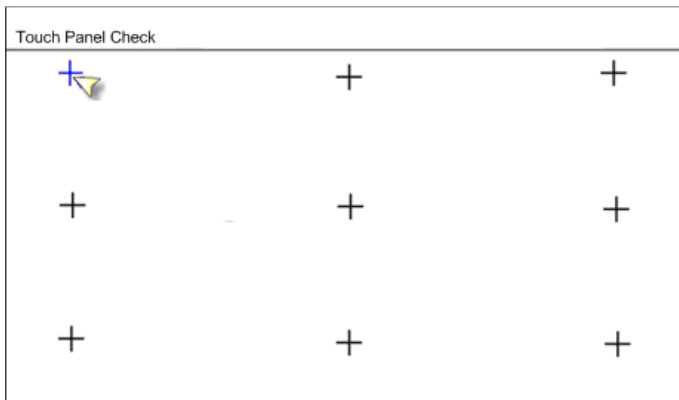

w\_d1462665

7. Touch panel calibration

Perform a touch-panel calibration, and set a value.

One + mark after another is displayed at locations (5 points) required for calibration. Press the center point.

When input of 5 points is complete, a display for set/reset appears.

- OK: Press Menu key
- Retry: Press Back key



d1462666

When it is desired to set the current value, the operation is completed by pressing the "Menu" key, and the display returns to the self-diagnosis screen.

To repeat the setting, or to stop touch panel calibration, press the Back key.

When the Return key is pressed, a + mark is displayed in the first position for performing calibration.

When this display appears, by pressing the Back key again, the display returns to the self-diagnosis screen.

# SP Mode List

## Settings Menu List

Menu level			Description
Level 1	Level 2	Level 3	
Application	Install from SD card (installation of application).		Update by installing application from SD card.
	Installation / update / activation		Activation can be performed using a SD card.
Storage	(SD card) Sum total capacity		When SD card is inserted, display the sum total capacity.
	(SD card) Free space		Display the free space when SD card is inserted.
	Erase the data in the SD card.		Erase the data in the SD card.
	(Internal storage) free space		Display the free space of the internal storage.

Menu level			Description
Level 1	Level 2	Level 3	
Voice input/ output	Setting of text read- aloud	Play back a sample	Play back a short sample of speech synthesis with the present setting.
		Always use your own settings (ON/OFF).	When not using the speech synthesis setting of each application and using the setting of this screen, switch ON.
		Default engine (engine: Select)	A dialog for setting the text read- aloud application to be used is displayed (when having installed plural text read-aloud applications).
		Install speech data	Select from the SD card, and install speech synthesis data.
		Audio speed (speed: 5 selection levels)	Select audio speed.
		Language	
		Engine	
		Terminal information	Terminal state
Interface setting			
wi-fi setting			
Device IP address			
Legal information (display)			
Firmware version list			

Menu level			Description
Level 1	Level 2	Level 3	
Device setting	Server setting	Port number (input: 1-65535)	
	Control unit self-diagnosis	-	Perform self-diagnosis of control unit.



## Recovery Menu

Menu	Description
Reboot system now	System reboot (used to come out of recovery mode)
apply update from sdcard	Android firmware (OS) version update
wipe data/factory reset	Full format
wipe cache partition	-
wipe free area partition	-

---

MEMO